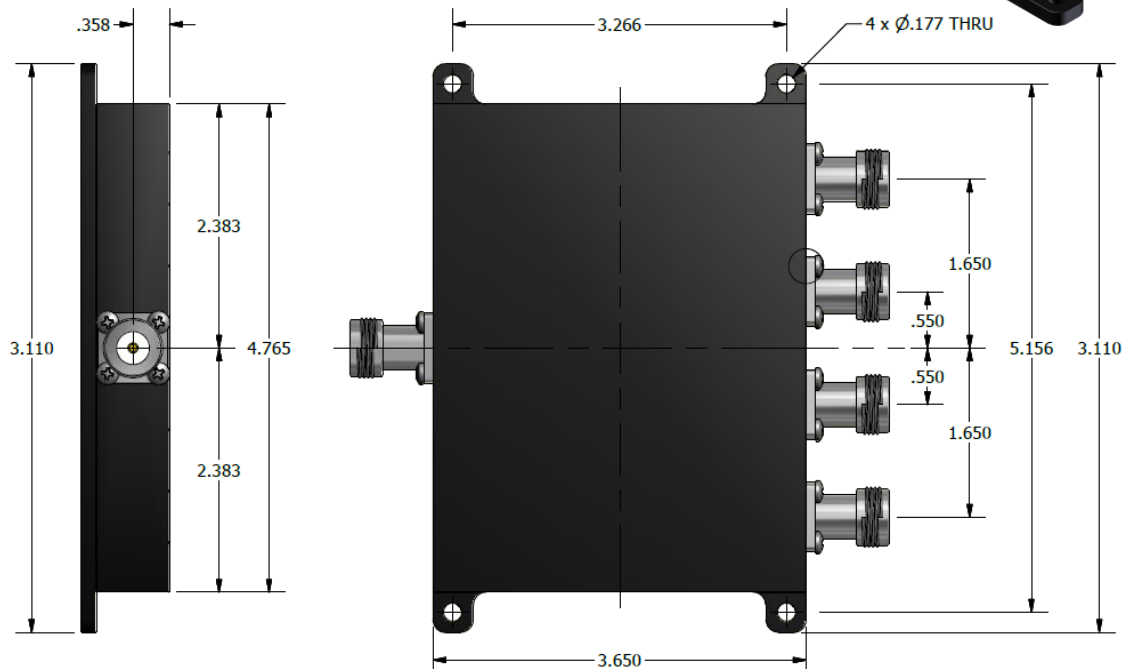

**121-700-2700-4-N** is a broad band Low-PIM 4-Way Power Combiner/Divider, designed specifically for the DAS and In-Building Wireless Industry. The same unit can work both as a combiner and a divider for signals between 698 MHz and 2700 MHz. Because of their rugged construction, they are indestructible and can be used in extreme weather and environmental conditions. Mounting holes enable them to be easily mounted on structures. It also has a low Insertion Loss with an good isolation between the channels. Type-N Connectors are standard.

**FEATURES:**

- Splits or Combines signals between 698 MHz - 2700 MHz
- Good Isolation
- Very Low Insertion Loss
- Low-PIM , - 153 dBc Typical
- 50 Watts as Splitter and 2 Watts as Combiner
- RoHS Complaint
- Mounting holes for easy mounting
- Weatherproof / Outdoor options available
- In Stock and Available Immediately

**MECHANICAL SPECIFICATIONS:**

Connectors:	Type-N Female (Std)
Housing Finish:	Aluminum Body
Mounting Method:	Mounting Holes
Temperature Range:	-55°C to 85°C
Humidity:	Up to 100%
Environment:	IP65 - Outdoor Use

**ELECTRICAL SPECIFICATIONS:**

Frequency Range:	698 MHz – 2700 MHz
Insertion Loss:	0.45 dB (Typ) (Over the theoretical loss of 6.0 dB)
VSWR:	< 1.20 (Typ)
Power Handling:	50 W (Avg) as Splitter 2 W (Avg) as Combiner
Impedance:	50Ω
Isolation:	21 dB (Typ)
PIM – 3 <sup>rd</sup> :	-153 dBc (Typ) (2Tone 43dBm each)

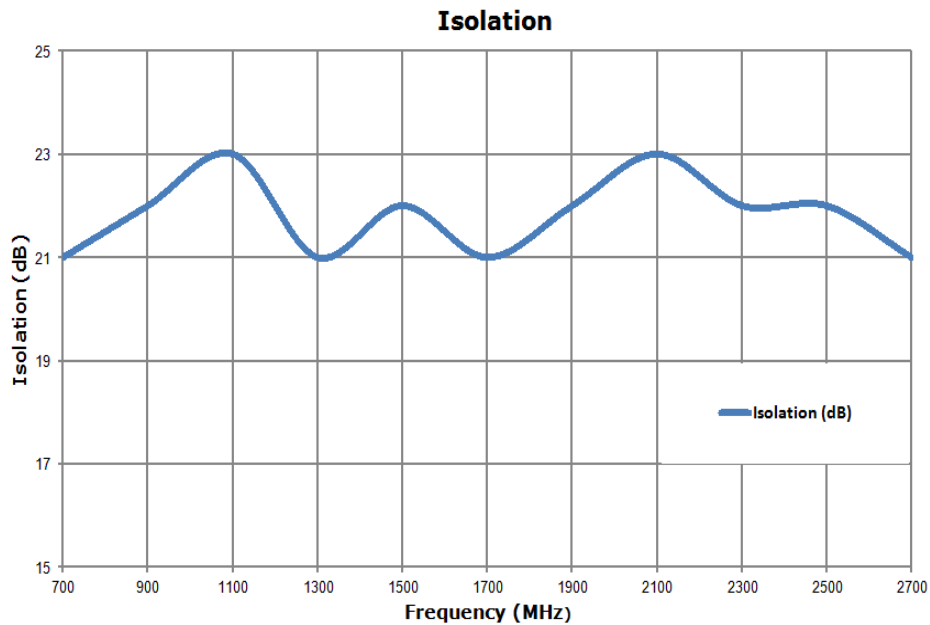
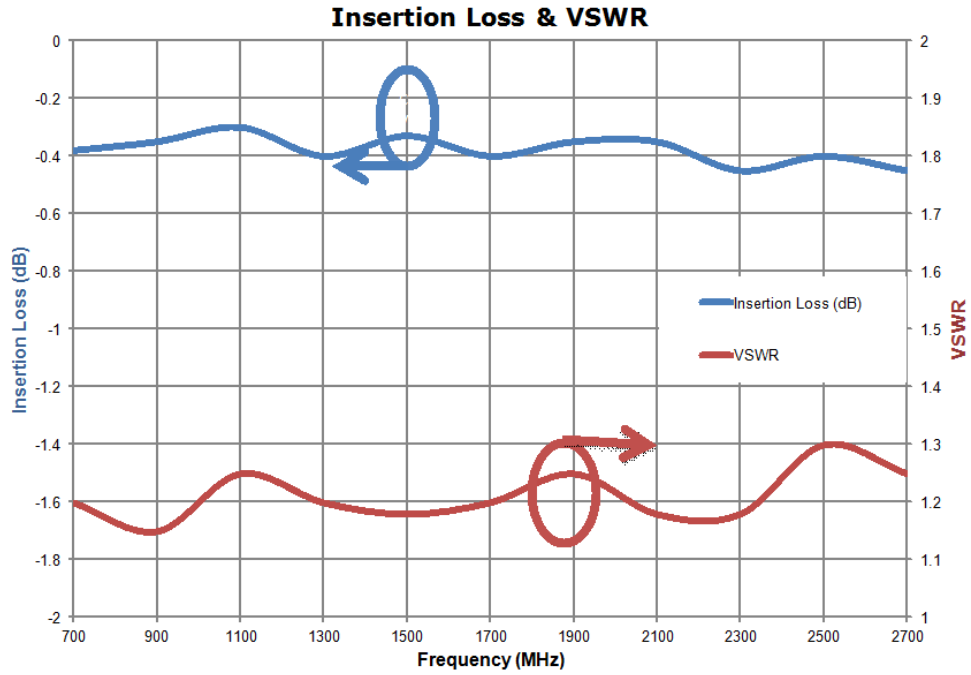

**APPLICATIONS:**

- DAS and In-Building Wireless
- Small Cell Networks
- Wi-Fi / WiMAX
- Cellular and GPS

Please contact our sales department at 914-230-4060 or [sales@InnowaveRF.com](mailto:sales@InnowaveRF.com) for any custom requirements.

© Innowave RF, LLC. All Rights Reserved. Specs can change without notice. Drawings are for reference purpose only.