

Innovation in Every Wave

211-700-2700-10 is a broadband 10 dB Power Directional Coupler operating from 698 MHz – 2700 MHz. It has low PIM, excellent directivity and coupling flatness across the entire band. It also exhibits a very low insertion loss along with outstanding VSWR at all three ports. Type-N and 7/16 DIN Connector options available.

FEATURES:

- Wide bandwidth, 698 MHz – 2700 MHz
- High Power Handling and High Isolation
- Excellent PIM, -157 dBc typical
- Low VSWR and Low Insertion Loss
- RoHS Compliant.
- Outdoor/Weather Resistant unit.
- In Stock and Available Immediately.

SPECIFICATIONS:

Frequency Range:	698 MHz – 2700 MHz
Insertion Loss:	0.5 dB (Typ)
Isolation:	34.00 dB (Typ)
VSWR:	1.25 (Typ)
Power Handling:	500 W (Avg)
Coupling Accuracy:	±0.60 dB (Typ)
PIM – 3 rd :	-157 dBc (Typ) (2Tone 43dBm each)
Temperature Range:	-55°C to 85°C
Humidity:	Up to 100%
Environment:	IP65 – Outdoor Use

APPLICATIONS:

- DAS
- Wi-Fi / WiMAX
- Cellular and GPS
- Communication Transmitter and Receiver
- Public Safety and ISM
- Instrumentation

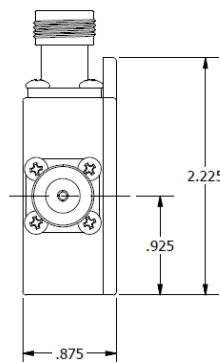
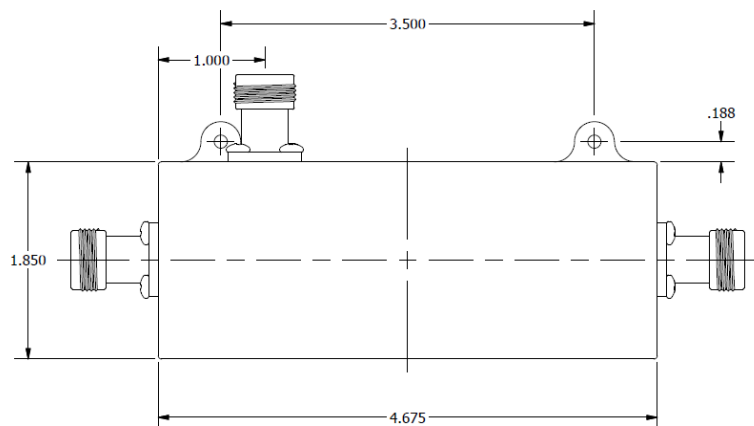
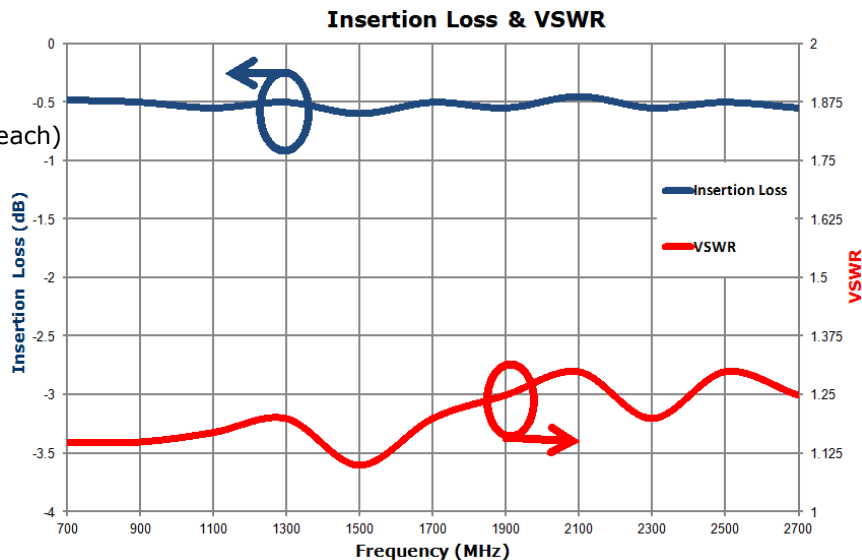
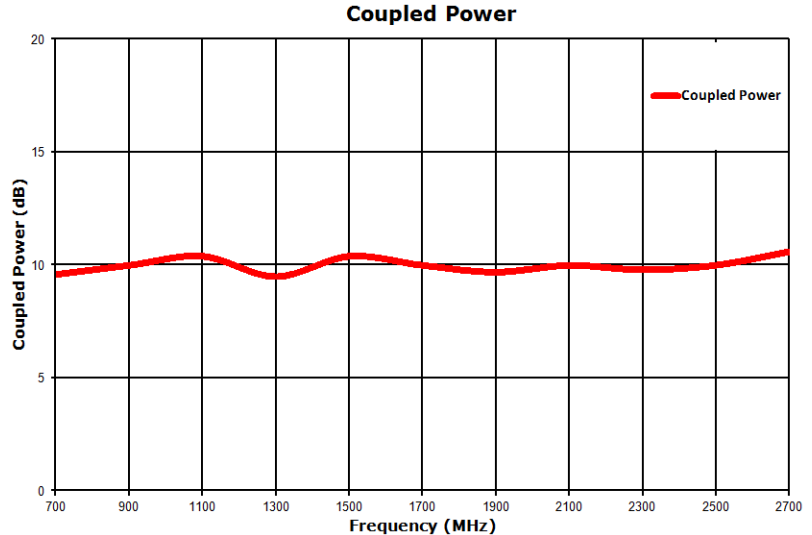

Please contact our sales department at 914-230-4060 or sales@InnowaveRF.com for any custom requirements.
 © Innowave RF, LLC. All Rights Reserved. Specs can change without notice. Drawings are for reference purpose only.